

Name: _____ Teacher Code: _____

ONE-POINT PERSPECTIVE: BOXES

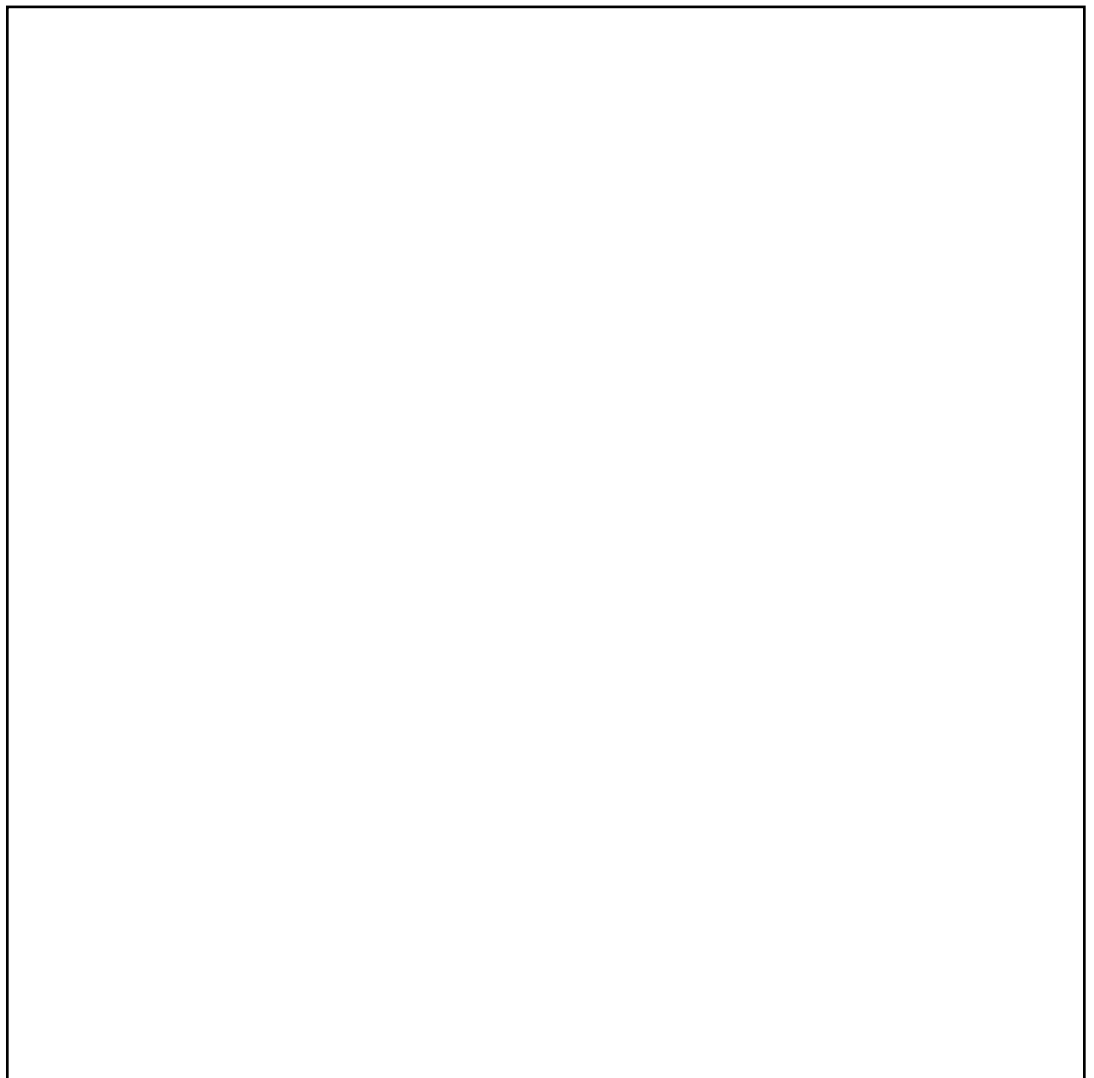

ONE-POINT PERSPECTIVE: SHAPES

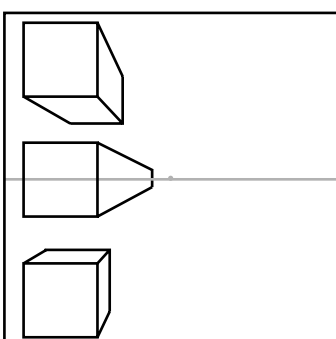
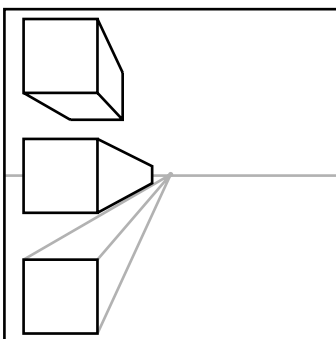
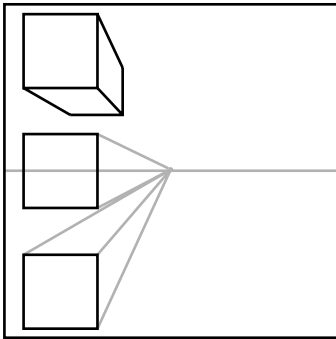
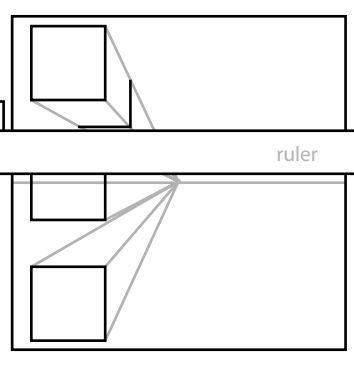
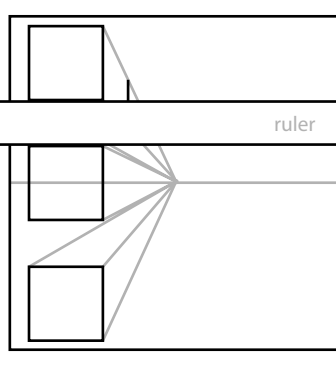
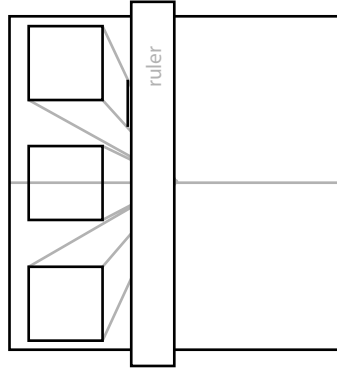
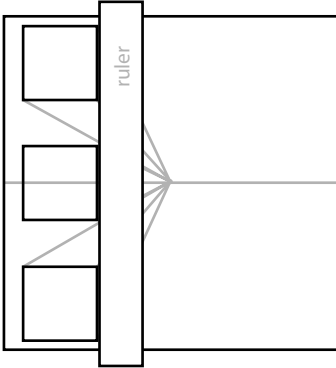
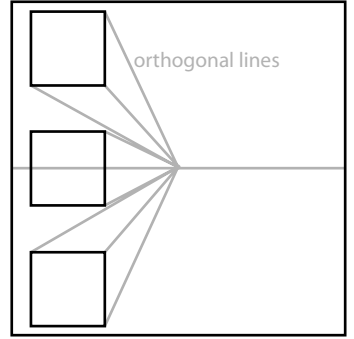
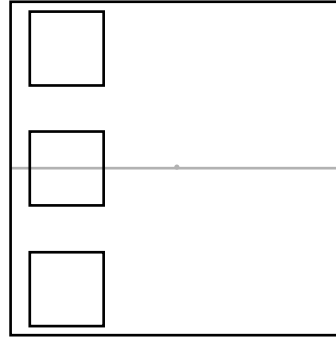
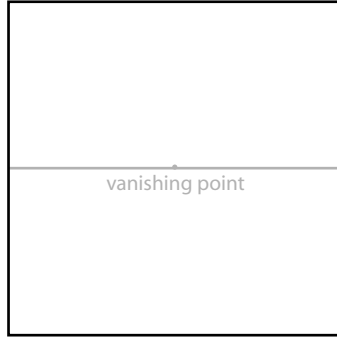
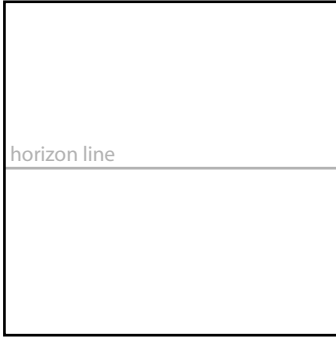
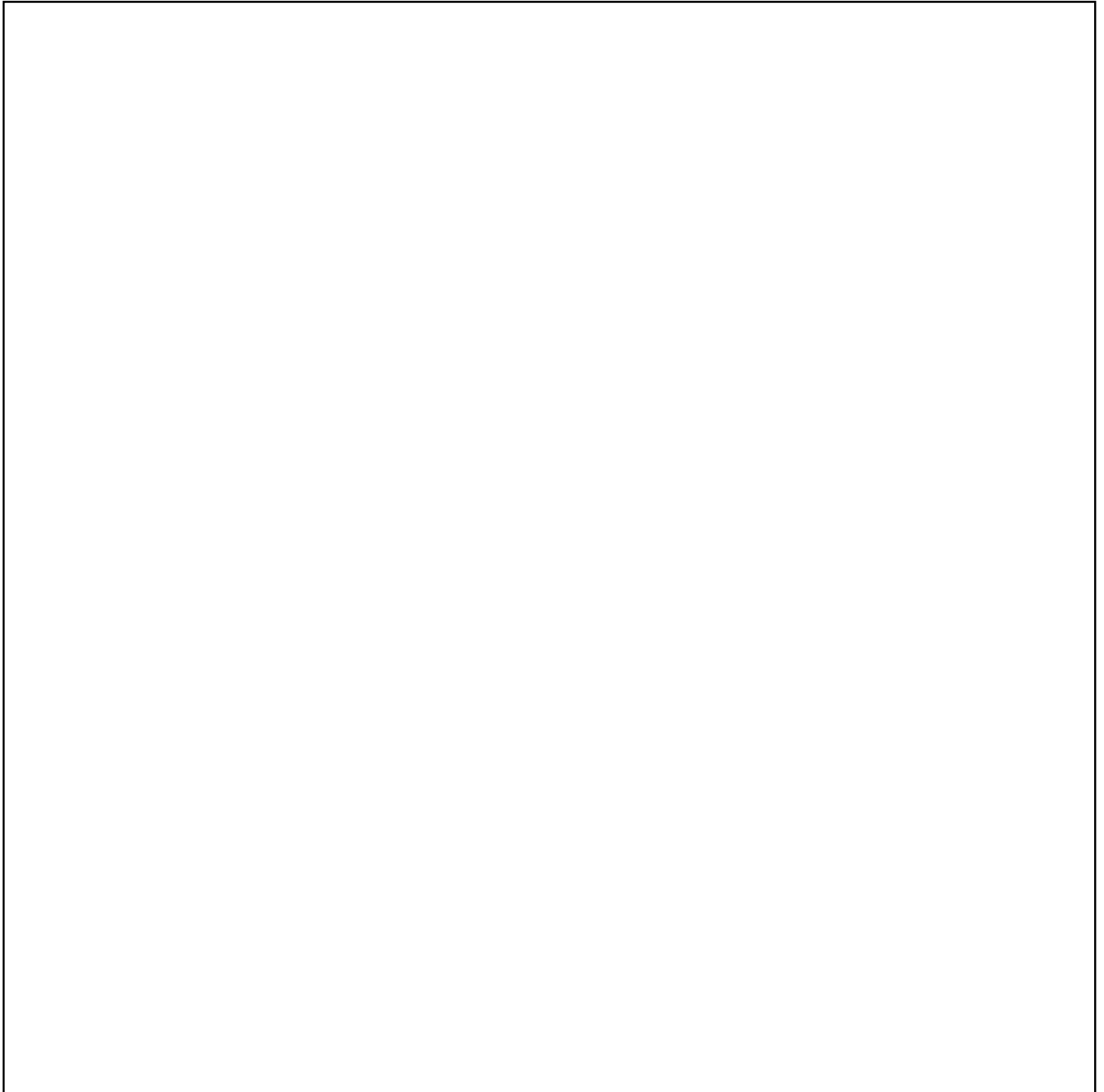
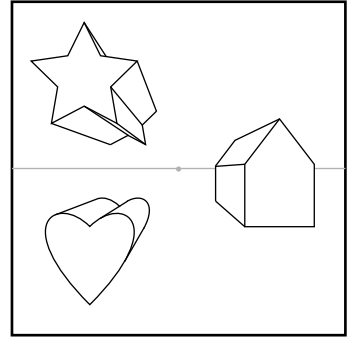
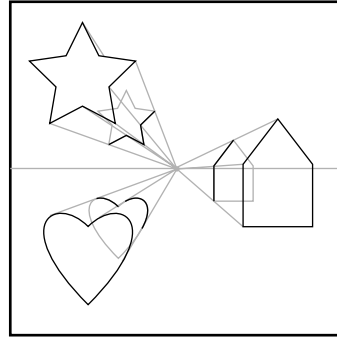
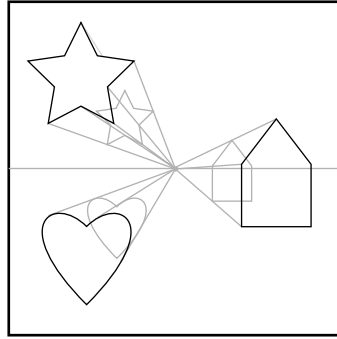
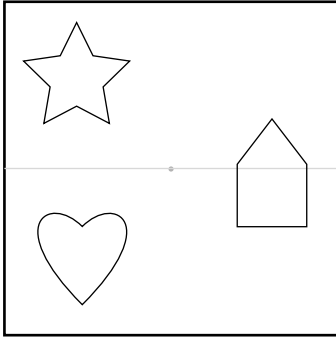

ONE-POINT PERSPECTIVE: LETTERS

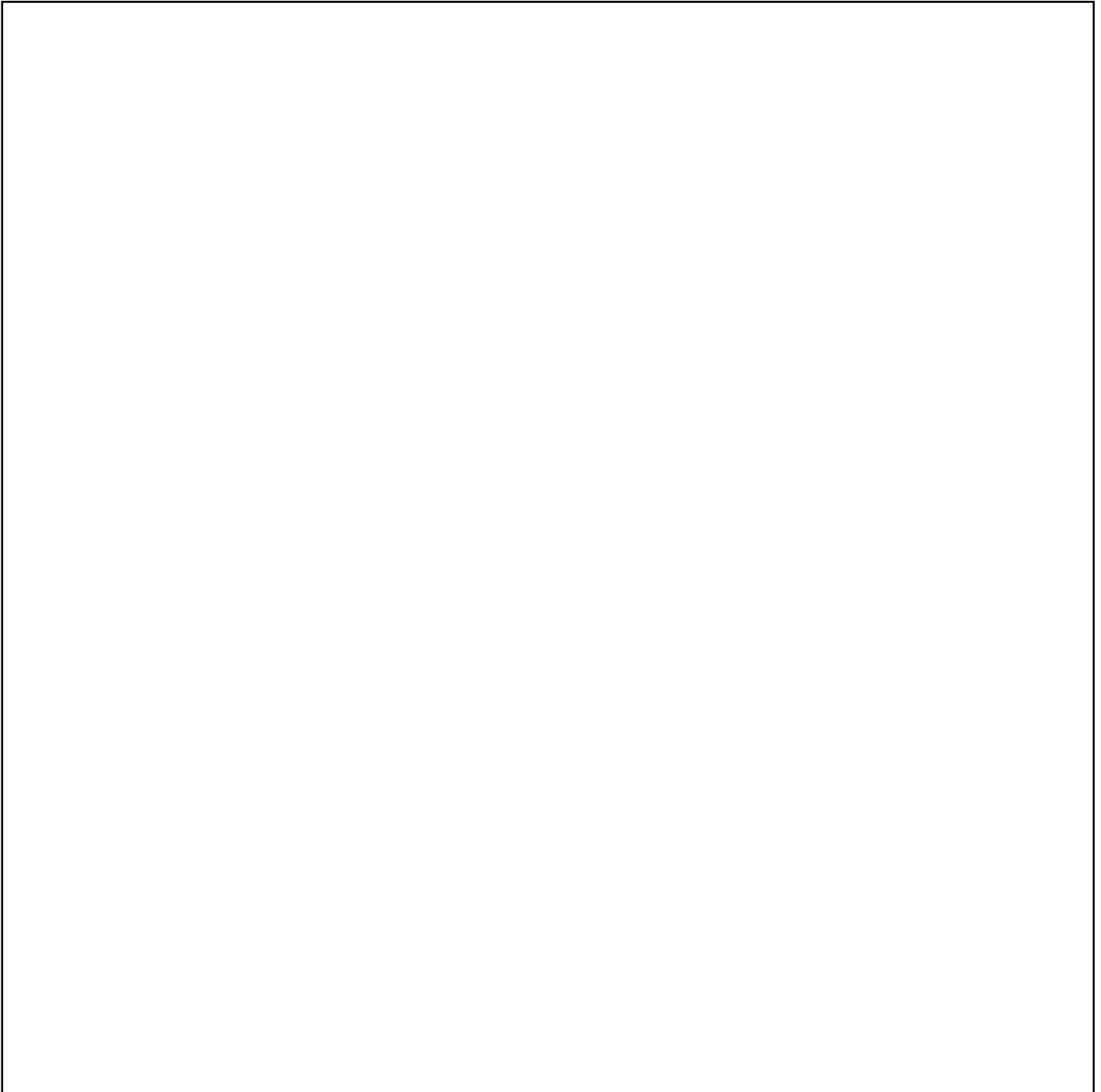
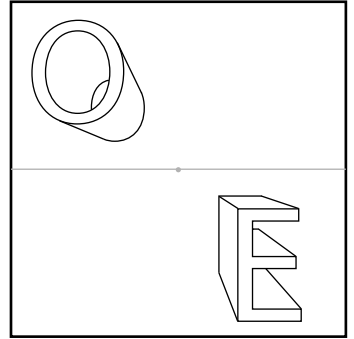
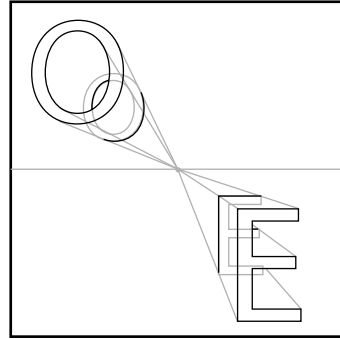
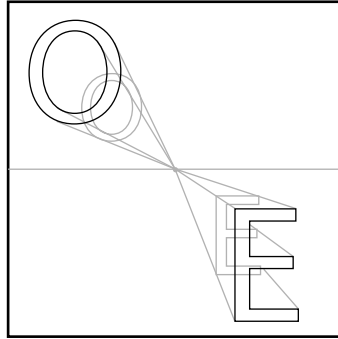
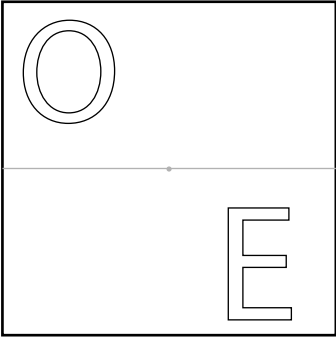

ONE-POINT PERSPECTIVE: ROOM

